

TRADEWINDS® Fabric Pop-Up Display System

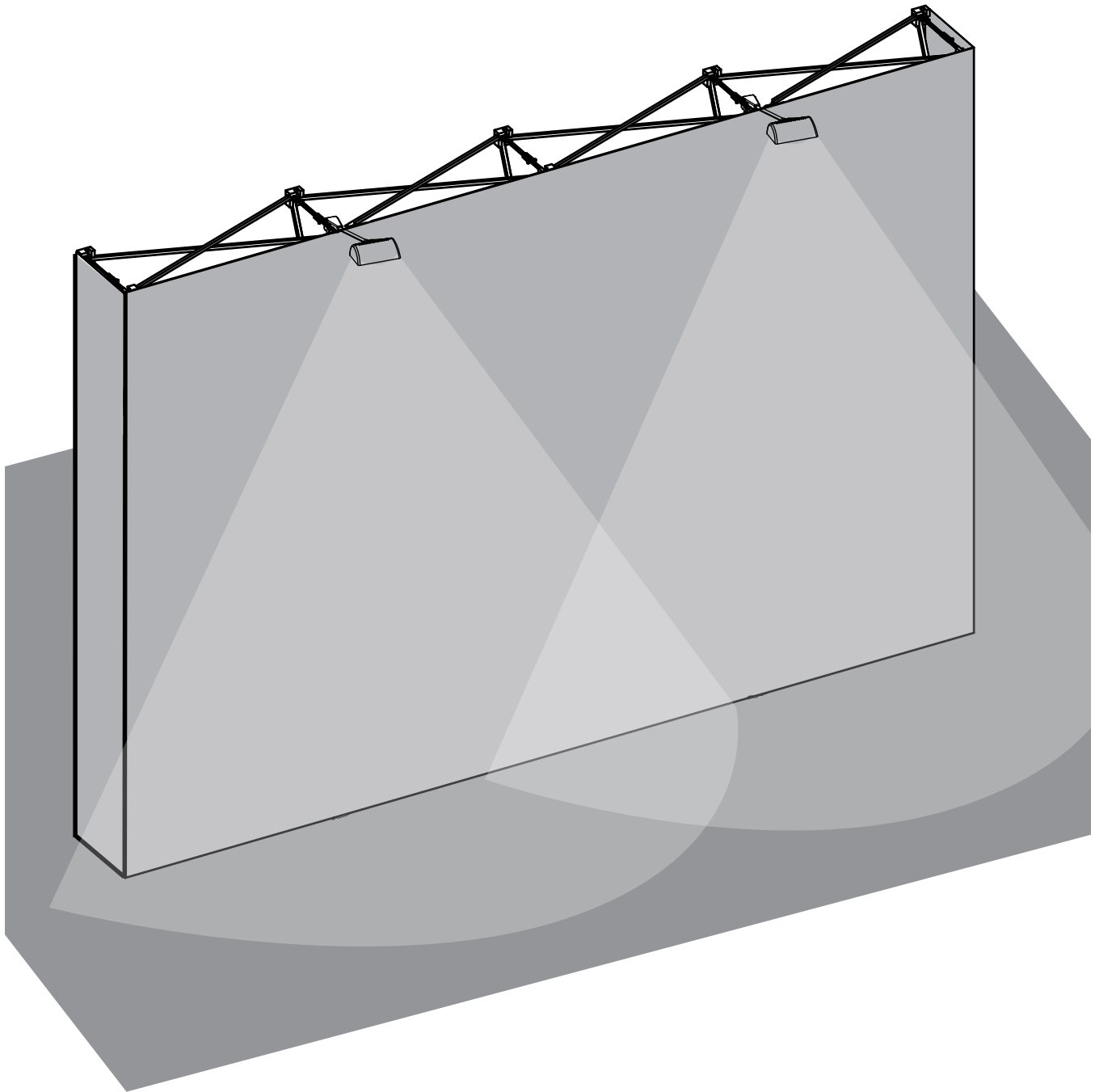

Fabric Pop-Up Set-Up Instructions

Fabric Pop-Up Models

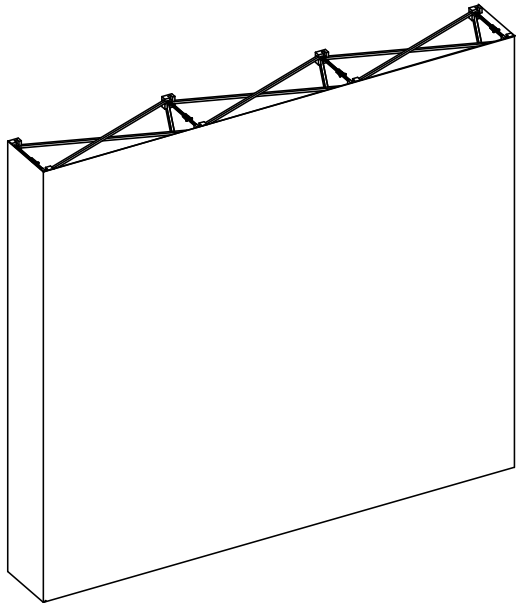

8' STRAIGHT WITH END PANELS

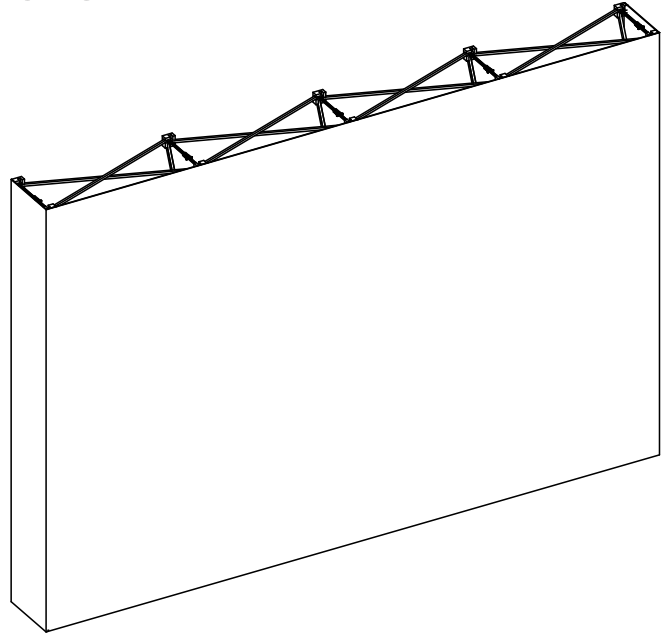

10' STRAIGHT WITH END PANELS

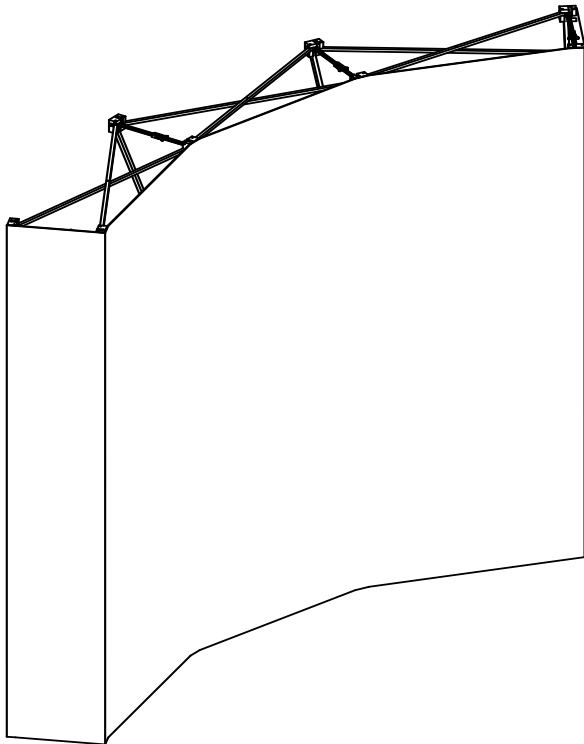

8' CURVED WITH END PANELS

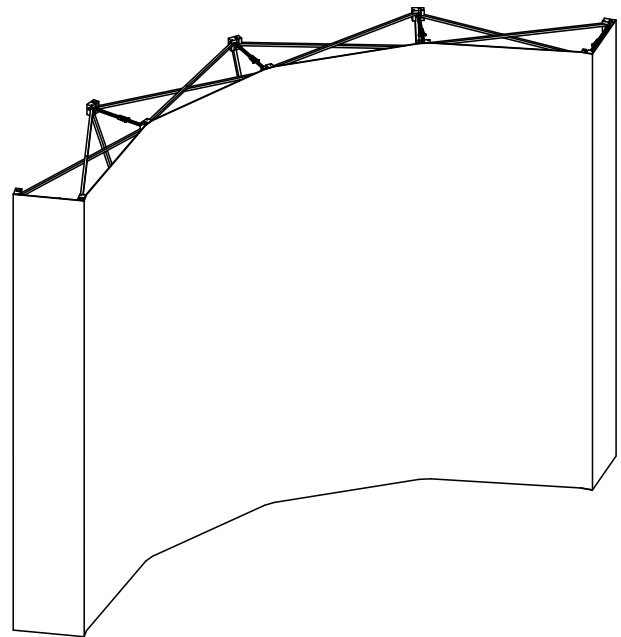

10' CURVED WITH END PANELS

Frame Set-Up

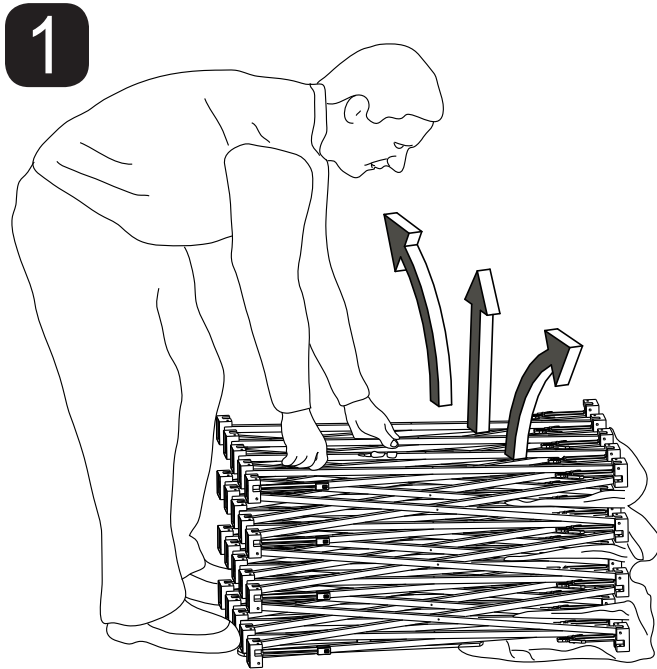

Expand the frame up and out until the hub connectors are almost touching.

Lay the frame down so the leveling feet are on the floor and the fabric covered hubs are positioned away from you. Grab the top frame rods near the middle, and lift up allowing the frame to expand.

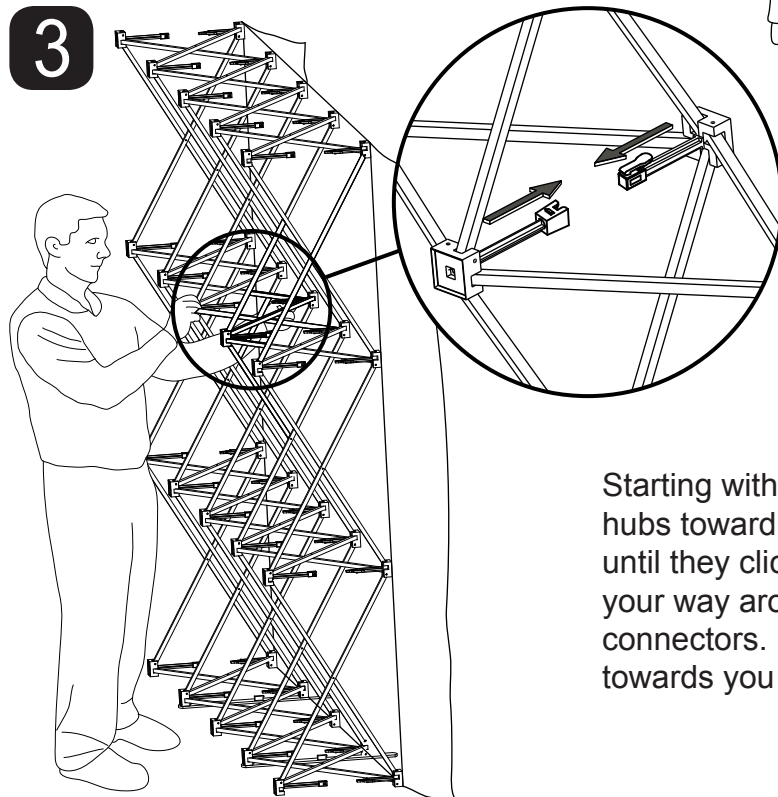
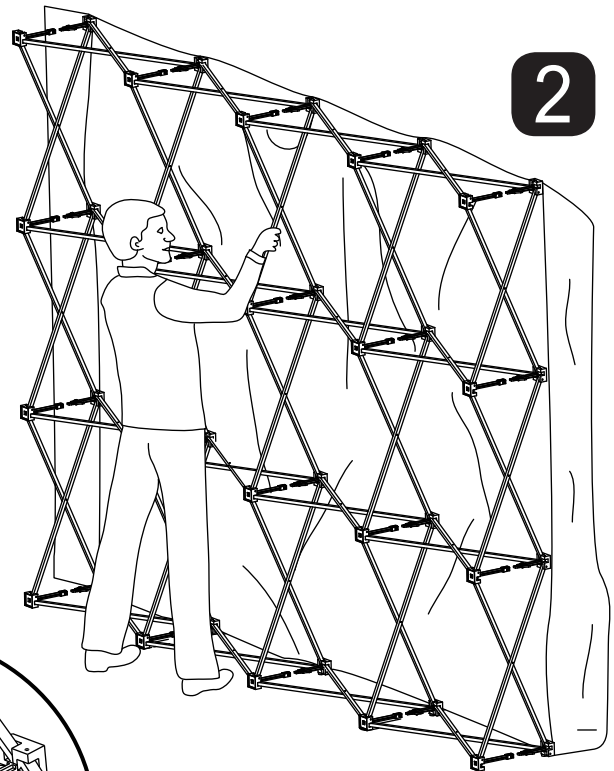

Starting with the hubs nearest you, push the hubs toward one another joining the connectors until they click, locking them together. Work your way around the frame, fastening all the connectors. Lean the top of the frame back towards you to reach the top row.

End Panels

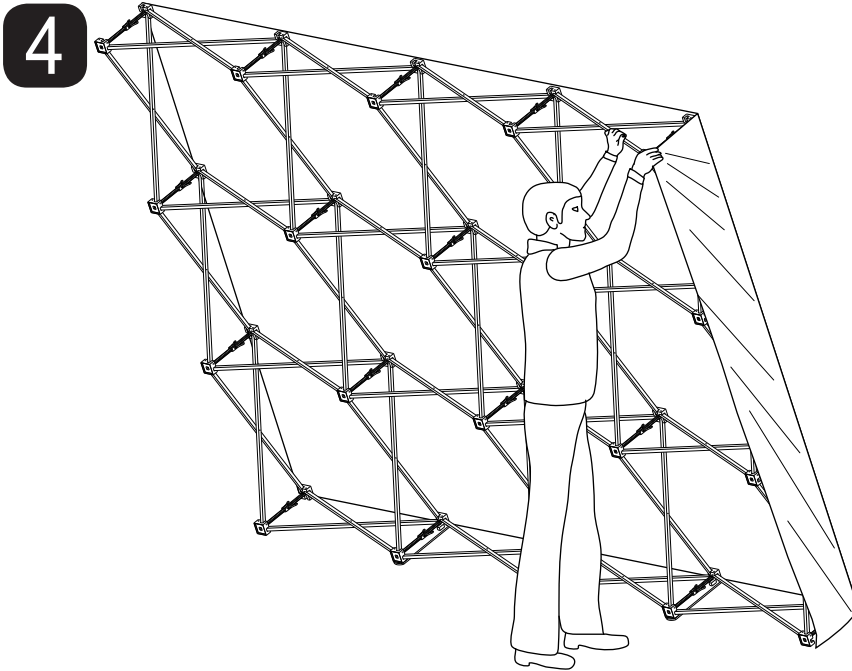

To attach end panels, stand behind the frame near one corner then lean the frame back towards you to grab the top unattached corner of one end panel. Do not stretch fabric excessively, but pull the end panel back to match the hook and loop patch on the side of the top hub with the patch on the end panel. Press firmly to attach the hook and loop patches together.

5

To assemble lights, slide directly on to top hub of frame.

Return the frame to its upright standing position and work your way down the side of the end panel to attach the remainder of the hook and loop patches together. Repeat the same steps to attach the opposite end panel.

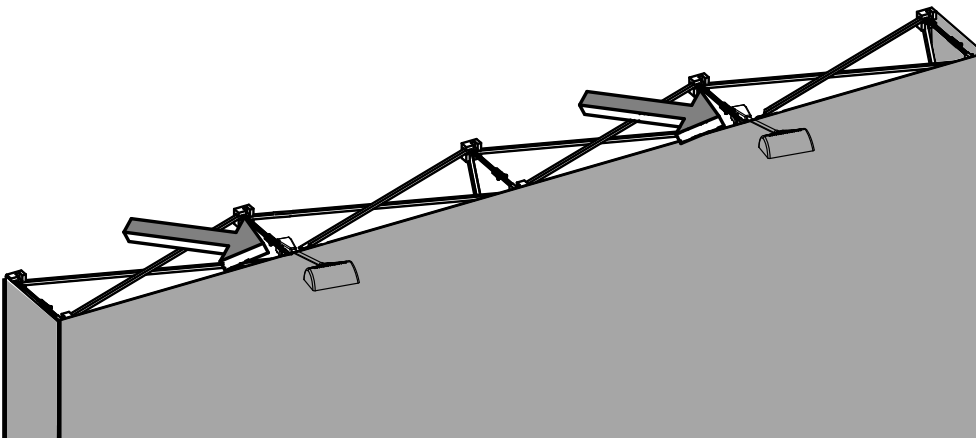
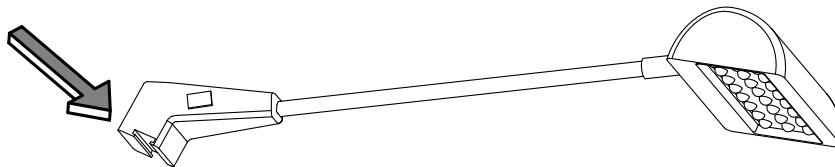

Frame Dismantle

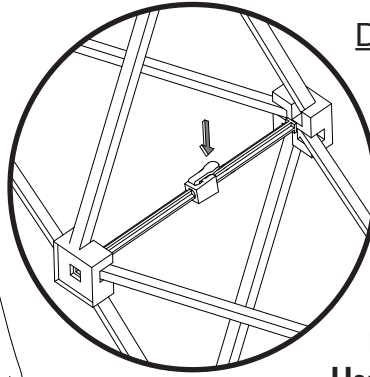
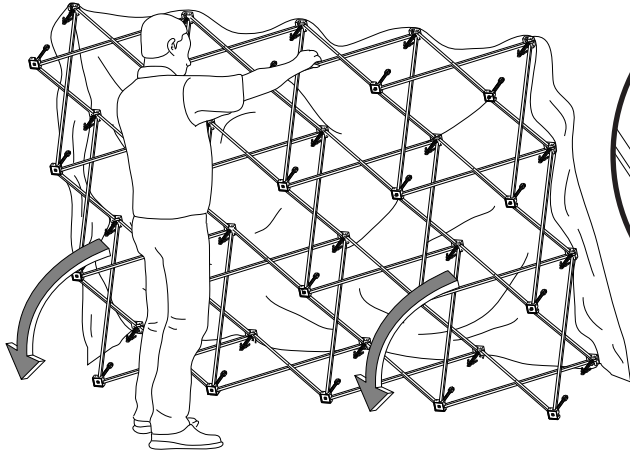

Detach fabric end panels before collapsing frame.

Release the frame connectors - leaving the center connector for last. Make sure all the connectors are completely separated before collapsing frame.

Use caution as the aluminum rods can bend if forced. Allow the frame to partially collapse then tilt the frame towards you and lay the frame on the floor with the fabric up.

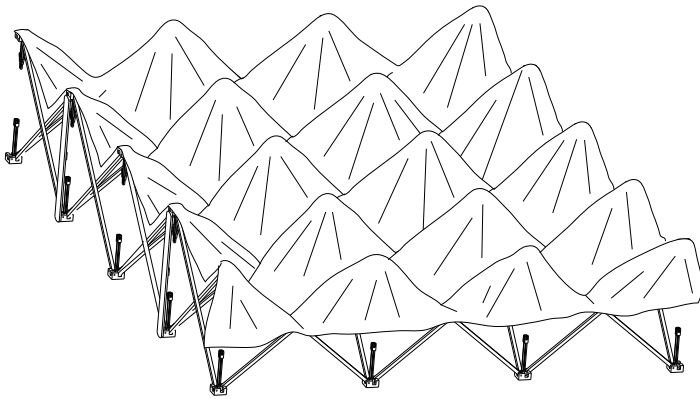

With the frame on the floor, arrange the fabric so it is spread evenly across the frame. This will prevent the fabric from bunching up when the frame is fully collapsed.

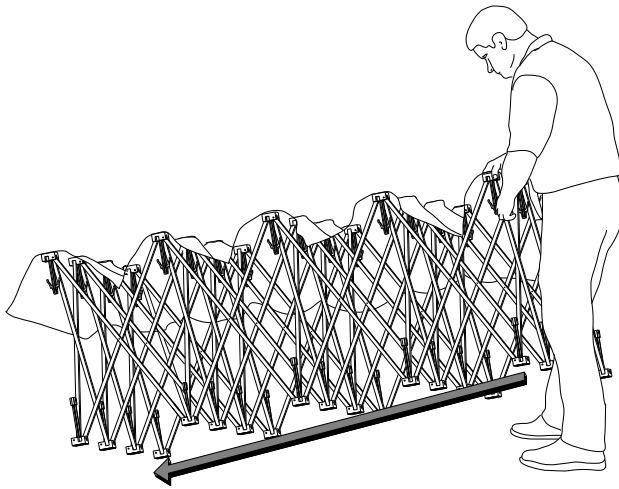

Pick one corner of the frame up and walk it over to the diagonal corner, fully collapsing the frame. With frame fully collapsed, pack display into soft-sided wheeled bag or hard case for storage and transport.

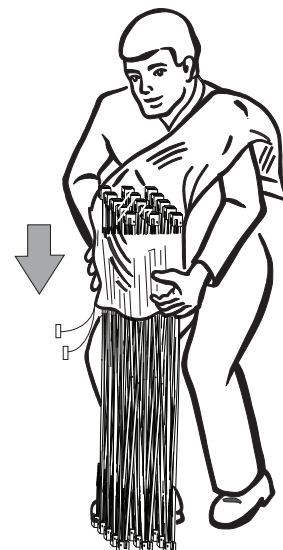

Place frame in protective bag.
Pack into wheeled bag or hard case.

Graphic Cover Replacement _____

Set up the frame according to the instructions.

Lay frame on floor with the cover facing up.

Remove the cover by detaching the hook and loop patches on the backside of the cover from the loop patches on the frame hubs.

Unfold the replacement cover completely and position it over the frame.

Starting at one of the top corners, attach the hook and loop patch on the replacement cover to the loop patch on the frame. Continue to work along the top edge attaching the rest of the hook and loop patches, then move to one of the bottom corners of the frame to connect the hook and loop patches along the bottom edge. Finish by connecting the sides and ends of the cover to smooth the fabric.

